

**Vooremaa 34. meistrivõistlused
kreeka-rooma maadluses**

Jõgeva

19.10.2013

Endel Treiman

Kätri-Avelin Säärits

Vooremaa 34. auhinnavõistlused kreeka-romaa maadluses

Jõgeva

19.10.2013

NOORTE VANUSEGRUPP 2002 JA NOOREMAD:

20 kg

- 1 ROBIN KRISTJUHAN, Palusalu
- 2 RENÄRS FREIJS, Ferrum
- 3 TOMS JAKOVLEVS, Ferrum
- 4 KARL-SANDER TSIPP, Jaan

25 kg

- 1 JUHAN KRISTJUHAN, Palusalu
- 2 HELARI KÕREMÄE, Kadrina
- 3 SILVER TAGU, Leo
- 3 VADIM KRIVOV, Valga
- 5 REIMO RATSOV, Kadrina
- 5 VIRGO VÄHK, Tapa
- 7 KARMO KAJANDI, Hammerlock
- 8 KRISTO PRINKEN, V-Maarja
- 9 JOHAN MARKUS JÕESAAR, Ramm
- 10 TRISTAN REINTAM, Jaan
- 10 KEVIN HILPUS, Jaan
- 12 INDREK MÄNNIK, Jaan
- 13 OSKAR SÄÄRITS, Ramm
- 14 TORMI TUUL, Jaan
- 15 SIIM-UKU OJA, Ramm
- 16 KEVIN NURMBEK, ABerg

30 kg

- 1 ROBIN LUMILA, Aberg
- 2 MARTIN ANNUK, Ramm
- 3 KRISTJAN JAAGO, V-Maarja
- 3 SANDER TAGU, Leo
- 5 JOEL VISNAPUU, V-Maarja
- 5 KRISTO LEBIN, Juhan
- 7 HUGO LOOG, Tapa
- 8 RENO-RENE PADAR, Jaan
- 9 ALANS TREIJS, Ferrum
- 10 GEORG LUMILA, Aberg
- 11 ROBIN-JOHANNES PADAR, Jaan
- 12 AIN-ALAR PUNDONEN, Valga
- 13 IGOR MUZIKA, Tapa
- 14 RÜDOLFS JÄRVALDS, Ferrum
- 15 KRISTO MERILAIN, Palusalu
- 16 VJATSESLAV BERJOZKIN, Valga
- 17 NIKITA MEZOV, Hammerlock
- 18 JARMO JÄRVISTE, Juhan
- 19 KARL KUSTAS KALEV, Ramm
- 20 JOHANNES OJASAAR, Ramm

35 kg

- 1 KALLE LAISARV, Tapa
- 2 EKKE-KÕU LEITHAM, Palusalu
- 3 ANDER JÄRV, Ramm
- 3 KARMO MÕTUS, Lapiti
- 5 HANNO KÄÄRIK, Lapiti
- 5 PEETER PRAGI, Lapiti
- 7 ROBERT MHITARJAN, Aberg
- 8 HELMUT MITROVSKI, Tapa
- 9 DAN ŠEMELJOV, Valga
- 10 MARCUS BUGERA, Tapa
- 11 RICHARD-TASUJA AVALD, Emü
- 12 ALVIS JAKOVLEVS, Ferrum
- 13 RALTS LÜKINS, Ferrum
- 14 HENDRIK RÄMMAN, Martna
- 15 ANDREAS SOONSEIN, Ramm
- 16 RADION TUMANOVSKI, Tapa
- 17 GIRTS JAKOVLEVS, Ferrum
- 18 SILVER SUNNI, Hammerlock
- 18 FREDERIK KINKAR, Hammerlock

40 kg

- 1 RAIMOND UIBO, Leo
- 2 JEGOR SAHNO, Tapa
- 3 ARON AUN, Juhan
- 3 STEVEN TILGAR, Jaan
- 5 STEVEN VAIGU, Rakvere
- 5 REENO-AKSEL AAVA, V-Maarja
- 7 MATVEI STARIKOV, Aberg
- 8 DANIEL TŠIRONOV, Tapa

50 kg

- 1 ERIC-RICHARD PENING, Aberg
- 2 ALLAN DAVID ŠEVTSOV, Tapa
- 3 SANDER ROOSILEHT, Juhan
- 3 ROBYN PAULBERG, Leo
- 5 KARL LOGBERG, Palusalu
- 5 SILVO SOOSAAR, TÜ ask
- 7 HENDRIK PRIISAAR, Nelson
- 8 KENN KIIS, Valga

.+50 kg

- 1 XSANDER SOLBAJA, Valga
- 2 RICHARD KARELSSON, Nelson
- 3 OTT HELISTE, TÜ ask
- 3 RUDOLF PRAGI, Lapiti
- 5 ATS PAJULA, Tapa
- 5 ARTUR MORGENSON, Tapa
- 7 MARKUS KRIISKÜT, Lapiti
- 7 MART TÖLLIMÄE, TÜ ask
- 9 KAAREL KANTS, Martna
- 10 JOHANNES SONBERG, Lapiti
- 11 KEIR KAAREL KALF, Hammerlock
- 12 RASMUS LIISMA, Aberg
- 12 VERNER PAJULA, Tapa
- 12 PAUL SONBERG, Lapiti
- 12 ATS JÜRGEN MARKUS KELL, Rakvere

ÕPILASTE VANUSEGRUPP 1998-2001

32 kg

- 1 KARL KRISTJAN VALDNA, Kadrina
- 2 KAAREL TAMM, Martna

35 kg

- 1 OLEG TŠABAN, Aberg
- 2 MARK ANISSIMOV, Valga

38 kg

- 1 MARKUS JULIUS HOLMBERG, Kadrina
- 2 MATTIAS SÄÄRITS, Ramm
- 3 KRISTJAN METSOJA, Kadrina
- 4 RALF METSAVAS, Valga

42 kg

- 1 EDVIN KIN, Nelson
- 2 MARKOS TALDOLDER, Jaan
- 3 ERKIN HÄRM, Kadrina
- 4 KALMER KUKK, Tartu valla

47 kg

- 1 RANET KALJOLA, Nelson
- 2 AHO LEITHAM, Palusalu
- 3 JAAN GROSBERG, TÜ ask
- 3 JARMO VANMIK, Juhan
- 5 VALLO AINSAR, TÜ ask
- 5 TAURI ALTMÄE, Kadrina
- 7 ANDRIS PENT, V-Maarja
- 8 TANEL ARMI, Tartu vald
- 9 JAANIS SOOSAAR, Martna

53 kg

- 1 JEGOR JAKOVLEV, Tapa
- 2 KRISTO KREEK, Ramm
- 3 JURI SEMJONOV, Tapa
- 3 ANTI PRIVITS, Tartu vald
- 5 DENIS RUDNAS, Tapa
- 5 ANVAR SILD, Kadrina
- 6 MAGNAR SIINMAA, Leo

59 kg

- 1 ANDREAS VÄLIS, Juhan
- 2 UKU LEITHAM, Palusalu
- 3 SILVER ROOSILEHT, Juhan
- 4 SANDER REEMETS, Emü

66 kg

- 1 RANDEL UIBO, Leo
- 2 HANNES VÄLIS, Juhan
- 3 KRISTO KALJUMAA, Juhan
- 3 JANEK ALEKAND, Tartu vald
- 5 KARLI PÄRNA, Tartu vald
- 6 GEORG JAKIMAINEN, Tapa

73 kg

- 1 ARDO PAJUR, Juhan
- 2 URMIS VEIMANN, Juhan
- 3 GEORG KOVZAROV, Aberg
- 4 JOOSEP ALLAN KAER, Hammerlock

85 kg

- 1 JOHAN TAANIEL, ŠEVTSOV, Tapa
- 2 KARL OSSI, Rakvere
- 3 TAURI TADOLDER, Jaan
- 4 LEMBIT LOODUS, Juhan
- 5 UKU LAIK, Valga

Vooremaa 34. meistrivõistlused kreeka-roma maadluses

Jõgeva

19.10.2013

Weight category	32	kg
-----------------	----	----

Nr	Name	Weight	Country	Pools competitions								Points	Place
				1.round								Kval.	
					Passivity	Time							
1.pool													
1	KARL KRISTJAN VALDNA, Kadrina	2		4								4	1
				11	SV							11	
2	KAAREL TAMM, Martna	1		0								0	2
				6								6	

CHIEF OF OFFICIALS	Endel Treiman
CHIEF OF SECRETARY	Kätri-Avelin Säärits

Vooremaa 34. meistrivõistlused kreeka-rooma maadluses

Jõgeva

19.10.2013

Weight category	35	kg
-----------------	-----------	----

Nr	Name	Weight	Country	Pools competitions								Points	Place
				1.round								Kval.	
					Passivity	Time							
1.pool													
1	MARK ANISSIMOV, Valga			2	0							0	2
					0							0	
2	OLEG TŠABAN, Aberg			1	4							4	1
					4	SV						4	

CHIEF OF OFFICIALS	Endel Treiman
CHIEF OF SECRETARY	Kätri-Avelin Säärits

Vooremaa 34. meistrivõistlused kreeka-rooma maadluses

Jõgeva

19.10.2013

Weight category	V 38	kg
-----------------	------	----

Nr	Name	Weight	Country	Pools competitions						Points		Place
				1.round		2.round		3.round		Kval.	Tehn.	
				Passivity	Time	Passivity	Time	Passivity	Time			
1.pool												
1	MATTIAS SÄÄRITS, Ramm	2	$\frac{5}{4}$		3	$\frac{1}{8}$		4	$\frac{4}{3}$	SV	10 15	2
2	KRISTJAN METSOJA, Kadrina	1	$\frac{0}{0}$		4	$\frac{5}{4}$	SV	3	$\frac{0}{0}$		5 4	3
3	MARKUS JULIUS HOLMBERG, Kadrina	4	$\frac{5}{7}$		1	$\frac{4}{12}$		2	$\frac{4}{8}$		13 27	1
4	RALF METSAVAS, Valga	3	$\frac{0}{0}$		2	$\frac{0}{2}$		1	$\frac{0}{0}$		0 2	4

CHIEF OF OFFICIALS	Endel Treiman
CHIEF OF SECRETARY	Kätri-Avelin Säärits

Vooremaa 34. meistrivõistlused kreeka-rooma maadluses

Jõgeva

19.10.2013

Weight category **V 42** kg

Nr	Name	Weight	Country	Pools competitions						Points		Place
				1.round		2.round		3.round		Kval.	Tehn.	
				Passivity	Time	Passivity	Time	Passivity	Time			
1.pool												
1	MARKOS TALDOLDER, Jaan	2	$\frac{1}{3}$		3	$\frac{4}{3}$	SV	4	$\frac{4}{3}$	SV	9	2
2	EDVIN KIN, Nelson	1	$\frac{4}{11}$		4	$\frac{4}{8}$		3	$\frac{4}{7}$	SV	12	1
3	KALMER KUKK, Tartu valla	4	$\frac{1}{5}$		1	$\frac{0}{3}$		2	$\frac{0}{0}$		1	4
4	ERKIN HÄRM, Kadrina	3	$\frac{3}{6}$		2	$\frac{0}{0}$		1	$\frac{0}{0}$		3	3
											6	

CHIEF OF OFFICIALS	Endel Treiman
CHIEF OF SECRETARY	Kätri-Avelin Säärits

Vooremaa 34. meistrivõistlused kreeka-rooma maadluses

Jõgeva

19.10.2013

Weight category Kaal 47 kg

Place Koht	Tour Préliminaire Eelring	1/4 Finale 1/4 Finaal	1/2 Finale 1/2 Finaal	Finale 1.-2. Finaal 1.-2.
1	1 RANET KALJOLA, Nelson	1 RANET KALJOLA, Nelson 5 4	1 RANET KALJOLA, Nelson 5 5	1 RANET KALJOLA, Nelson 5 5
5	2 VALLO AINSAR, TÜ ask	2 VALLO AINSAR, TÜ ask 0 0	3 JAAN GROSBERG, TÜ ask 0 0	
3	3 JAAN GROSBERG, TÜ ask	3 JAAN GROSBERG, TÜ ask 5 7	5 AHO LEITHAM, Palusalu 5 5	5 AHO LEITHAM, Palusalu 0 0
8	4 TANEL ARMI, Tartu vald	4 TANEL ARMI, Tartu vald 0 2	9 TAURI ALTMÄE, Kadrina 0 0	
2	5 AHO LEITHAM, Palusalu	5 AHO LEITHAM, Palusalu 5 5	9 TAURI ALTMÄE, Kadrina 0 0	1 RANET KALJOLA, Nelson
3	6 JARMO VANMIK, Juhan	6 JARMO VANMIK, Juhan 0 4	9 TAURI ALTMÄE, Kadrina 5 3	
9	7 JAANIS SOOSAAR, Martna	7 JAANIS SOOSAAR, Martna 0 0		
7	8 ANDRIS PENT, V-Maarja 1 3	8 ANDRIS PENT, V-Maarja 1 3		
5	9 TAURI ALTMÄE, Kadrina 4 8	9 TAURI ALTMÄE, Kadrina 4 8		

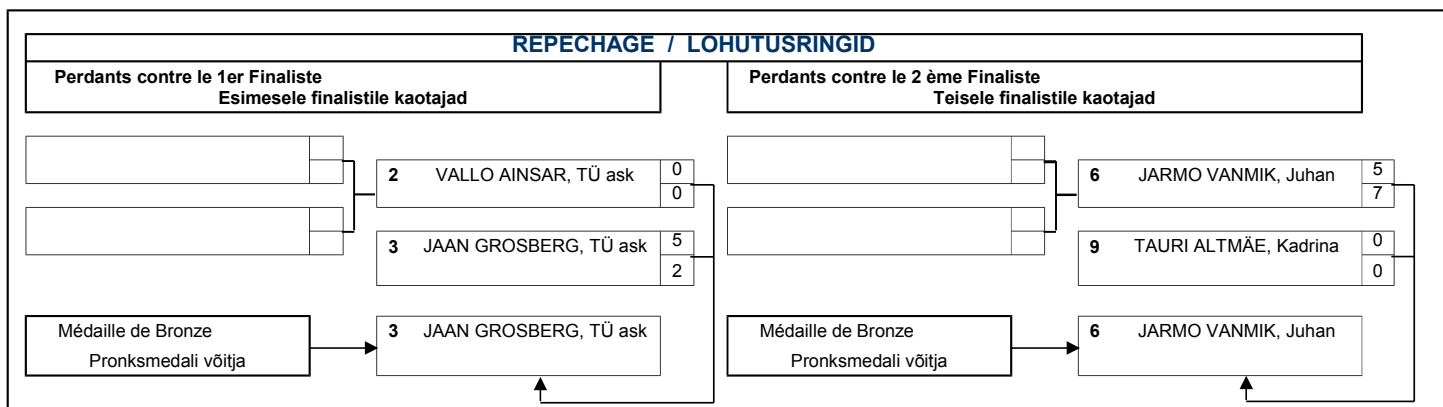

CHIEF OF OFFICIALS
CHIEF OF SECRETARY

Endel Treiman
Kätri-Avelin Säärits

Vooremaa 34. meistrivõistlused kreeka-rooma maadluses

Jõgeva
19.10.2013

Weight category Kaal V 53 kg

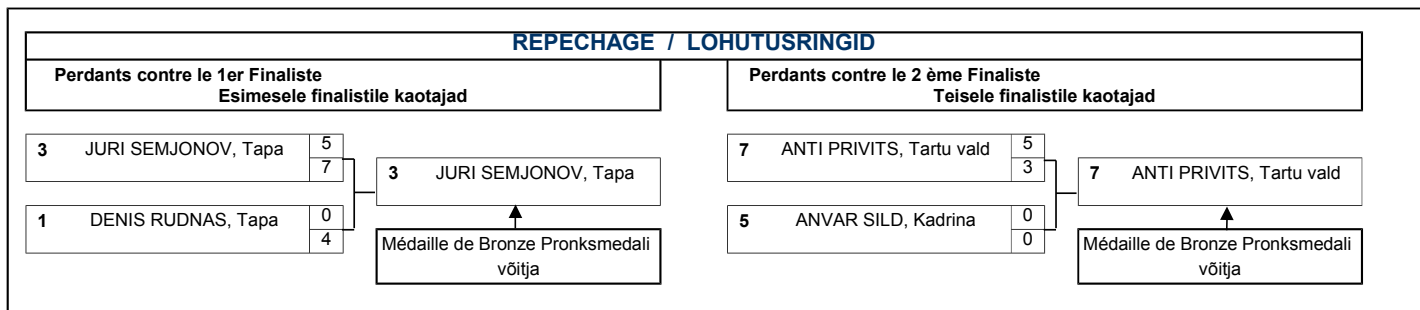
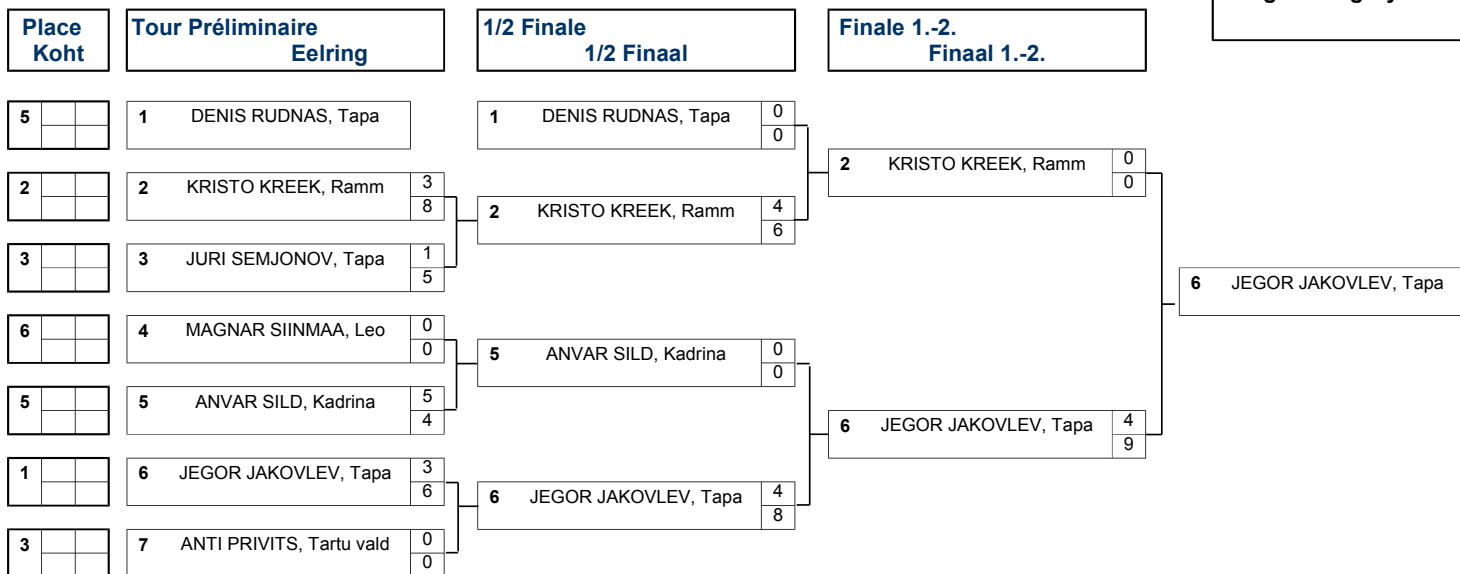

CHIEF OF OFFICIALS
CHIEF OF SECRETARY

Endel Treiman
Kätri-Avelin Säärirts

Vooremaa 34. meistrivõistlused kreeka-rooma maadluses

Jõgeva

19.10.2013

Weight category	59	kg
-----------------	-----------	----

Nr	Name	Weight	Country	Pools competitions									Points		Place		
				1.round			2.round			3.round			Kval.	Tehn.			
					Passivity	Time		Passivity	Time		Passivity	Time					
1.pool																	
1	SANDER REEMETS, Emü			2	0			3	0			4	0			0	4
					4				0				0			4	
2	SILVER ROOSILEHT, Juhan			1	4			4	0			3	0			4	3
					3	SV			0				0			3	
3	ANDREAS VÄLIS, Juhan			4	4			1	4			2	4			12	1
					4	SV			8				8			20	
4	UKU LEITHAM, Palusalu			3	0			2	4			1	5			9	2
					0				6	SV			4	SV		10	

CHIEF OF OFFICIALS	Endel Treiman
CHIEF OF SECRETARY	Kättri-Avelin Säärirts

Vooremaa 34. meistrivõistlused kreeka-romaa maadluses

Jõgeva
19.10.2013

Weight category Kaal 66 kg

Place Koht	Tour Préliminaire Eelring	1/2 Finale 1/2 Finaal	Finale 1.-2. Finaal 1.-2.						
3	1 KRISTO KALJUMAA, Juhan	1 KRISTO KALJUMAA, Juhan <table border="1"><tr><td>0</td></tr><tr><td>0</td></tr></table>	0	0	2 HANNES VÄLIS, Juhan <table border="1"><tr><td>1</td></tr><tr><td>3</td></tr></table>	1	3		
0									
0									
1									
3									
2	2 HANNES VÄLIS, Juhan	2 HANNES VÄLIS, Juhan <table border="1"><tr><td>4</td></tr><tr><td>6</td></tr></table>	4	6					
4									
6									
3	3 JANEK ALEKAND, Tartu vald <table border="1"><tr><td>1</td></tr><tr><td>4</td></tr></table>	1	4	4 RANDEL UIBO, Leo <table border="1"><tr><td>4</td></tr><tr><td>7</td></tr></table>	4	7	4 RANDEL UIBO, Leo <table border="1"><tr><td>3</td></tr><tr><td>7</td></tr></table>	3	7
1									
4									
4									
7									
3									
7									
1	4 RANDEL UIBO, Leo <table border="1"><tr><td>4</td></tr><tr><td>12</td></tr></table>	4	12						
4									
12									
5	5 KARLI PÄRNA, Tartu vald <table border="1"><tr><td>3</td></tr><tr><td>7</td></tr></table>	3	7	5 KARLI PÄRNA, Tartu vald <table border="1"><tr><td>0</td></tr><tr><td>0</td></tr></table>	0	0			
3									
7									
0									
0									
6	6 GEORG JAKIMAINEN, Tapa <table border="1"><tr><td>1</td></tr><tr><td>6</td></tr></table>	1	6						
1									
6									

4 RANDEL UIBO, Leo

REPECHAGE			
Perdants contre le 1er Finaliste Esimesele finalistile kaotajad	Perdants contre le 2ème Finaliste Teisele finalistile kaotajad		
1 KRISTO KALJUMAA, Juhan	3 JANEK ALEKAND, Tartu vald <table border="1"><tr><td>5</td></tr><tr><td>7</td></tr></table>	5	7
5			
7			
↑	3 JANEK ALEKAND, Tartu vald		
Médaille de Bronze Pronksmedali võitja	5 KARLI PÄRNA, Tartu vald <table border="1"><tr><td>0</td></tr><tr><td>0</td></tr></table>	0	0
0			
0			
	↑		
	Médaille de Bronze Pronksmedali võitja		

CHIEF OF OFFICIALS
CHIEF OF SECRETARY

Endel Treiman
Kättri-Avelin Säärirts

Vooremaa 34. meistrivõistlused kreeka-rooma maadluses

Jõgeva

19.10.2013

Weight category	73	kg
-----------------	----	----

Nr	Name	Weight	Country	Pools competitions									Points		Place
				1.round			2.round			3.round			Kval.	Tehn.	
					Passivity	Time		Passivity	Time		Passivity	Time			
1.pool															
1	URMIS VEIMANN, Juhan	2	$\frac{4}{8}$		3	$\frac{0}{0}$		4	$\frac{4}{4}$	SV		8	12	2	
2	GEORG KOVZAROV, Aberg	1	$\frac{0}{0}$		4	$\frac{4}{3}$	SV		3	$\frac{0}{0}$		4	3	3	
3	ARDO PAJUR, Juhan	4	$\frac{4}{8}$	SV	1	$\frac{4}{3}$	SV		2	$\frac{4}{6}$	SV	12	17	1	
4	JOOSEP ALLAN KAER, Hammerlock	3	$\frac{0}{0}$		2	$\frac{0}{0}$			1	$\frac{0}{0}$		0	0	4	

CHIEF OF OFFICIALS	Endel Treiman
CHIEF OF SECRETARY	Kätri-Avelin Säärts

Vooremaa 34. meistrivõistlused kreeka-roma maadluses

Jõgeva

19.10.2013

Weight category	85	kg
-----------------	----	----

Nr	Name	Weight	Country	Pools competitions															Points		Place				
				1.round			2.round			3.round			4.round			5.round			Kval.	Tehn.					
					Passivity	Time		Passivity	Time		Passivity	Time		Passivity	Time		Passivity	Time							
1.pool																									
1	LEMBIT LOODUS, Juhan			2	4			5	1			4	0			3	0			X	5			4	
					9	SV			4				0				0						13		
2	UKU LAIK, Valga			1	0			3	0			5	0			X	4	0			4	0			5
					0				0				0					0				0		0	
3	JOHAN TAANIEL, ŠEVTSOV, Tapa			4	4	SV		2	4			X	1	4			5	4			5	4			1
					4				3	SV				4	SV			8				16		19	
4	KARL OSSI, Rakvere			3	0			X	1	3			5	3			2	4			2	4			2
					1					2				5				5	SV			10		13	
5	TAURI TADOLDER, Jaan			X				1	3			2	4			4	0			3	0			7	3
									6				3	SV			0				3	0		9	

CHIEF OF OFFICIALS	Endel Treiman
CHIEF OF SECRETARY	Kättri-Avelin Säärirts

Vooremaa 34. meistrivõistlused kreeka-rooma maadluses

Jõgeva

19.10.2013

Weight category	20	kg
-----------------	----	----

Nr	Name	Weight	Country	Pools competitions									Points	Place	
				1.round			2.round			3.round					Kval.
					Passivity	Time		Passivity	Time		Passivity	Time			Tehn.
1.pool															
1	RENÄRS TREIJS, Ferrum			2	0		3	4		4	4		8	2	
					0			3			8		11		
2	ROBIN KRISTJUHAN, Palusalu			1	3		4	4		3	4		11	1	
					6			3			3	SV	12		
3	KARL-SANDER TSIPP, Jaan			4	0		1	0		2	0		0	4	
					4			0			0		4		
4	TOMS JAKOVLEVS, Ferrum			3	4		2	0		1	0		4	3	
					4			0			0		4		

CHIEF OF OFFICIALS	Endel Treiman
CHIEF OF SECRETARY	Kätri-Avelin Säärts

Vooremaa 34. meistrivõistlused kreeka-rooma maadluses

Jõgeva
19.10.2013

Weight category 25 kg
Kaal

Place Koht	Tour Préliminaire Eelring	1/4 Finale 1/4 Finaal	1/2 Finale 1/2 Finaal	Finale 1.-2. Finaal 1.-2.
13	0 6	1 OSKAR SÄÄRITS, Ramm 0 0	2 REIMO RATSOV, Kadrina 3 7	2 REIMO RATSOV, Kadrina 0 0
5		2 REIMO RATSOV, Kadrina 3 6	4 KARMO KAJANDI, Hammerlock 1 5	6 JUHAN KRISTJUHAN, Palusalu 5 3
9	6 8	3 JOHAN MARKUS JÕESAAR, Ramm 0 6	6 JUHAN KRISTJUHAN, Palusalu 5 5	6 JUHAN KRISTJUHAN, Palusalu 5 6
7	13 13	4 KARMO KAJANDI, Hammerlock 5 8	8 SILVER TAGU, Leo 0 0	16 HELARI KÕREMÄE, Kadrina 0 2
15	0 13	5 SIIM-UKU OJA, Ramm 0 0	10 KRISTO PRINKEN, V-Maarja 0 0	
1		6 JUHAN KRISTJUHAN, Palusalu 3 6	12 VADIM KRIVOV, Valga 0 3	
12	0 5	7 INDREK MÄNNIK, Jaan 0 0	13 VIRGO VÄHK, Tapa 0 0	
3		8 SILVER TAGU, Leo 5 3	16 HELARI KÕREMÄE, Kadrina 5 5	
10	0 3	9 TRISTAN REINTAM, Jaan 0 0		
8	3 4	10 KRISTO PRINKEN, V-Maarja 5 3		
16	0 8	11 KEVIN NURMBEK, ABerg 0 0		
3		12 VADIM KRIVOV, Valga 4 8		
5		13 VIRGO VÄHK, Tapa 5 3		
10	0 3	14 KEVIN HILPUS, Jaan 0 0		
14	0 6	15 TORMI TUUL, Jaan 0 0		
		16 HELARI KÕREMÄE, Kadrina 5 3		

2		
---	--	--

16	HELARI KÕREMÄE, Kadrina	5
		3

REPECHAGE / LOHUTUSRINGID

**Perdants contre le 1er Finaliste
Esimesele finalistile kaotajad**

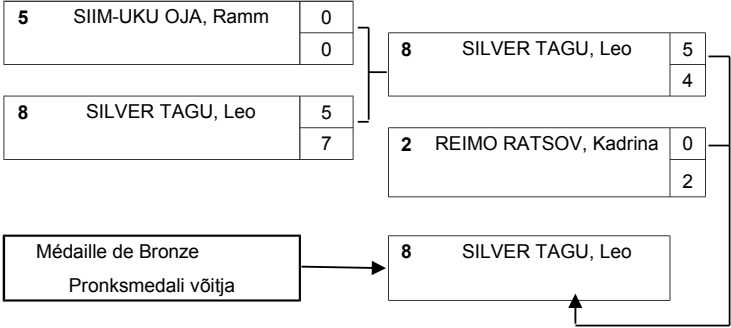

**Perdants contre le 2ème Finaliste
Teisele finalistile kaotajad**

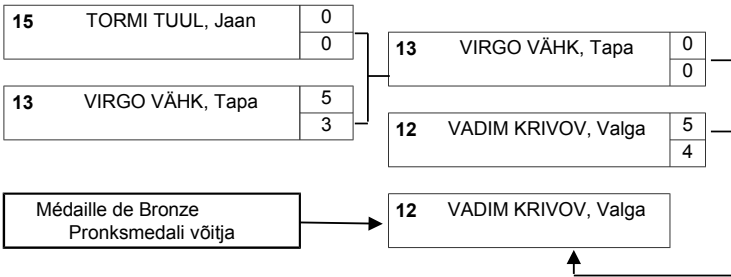

Vooremaa 34. meistrivõistlused kreeka-rooma maadluses

Jõgeva
19.10.2013

n 30 KG

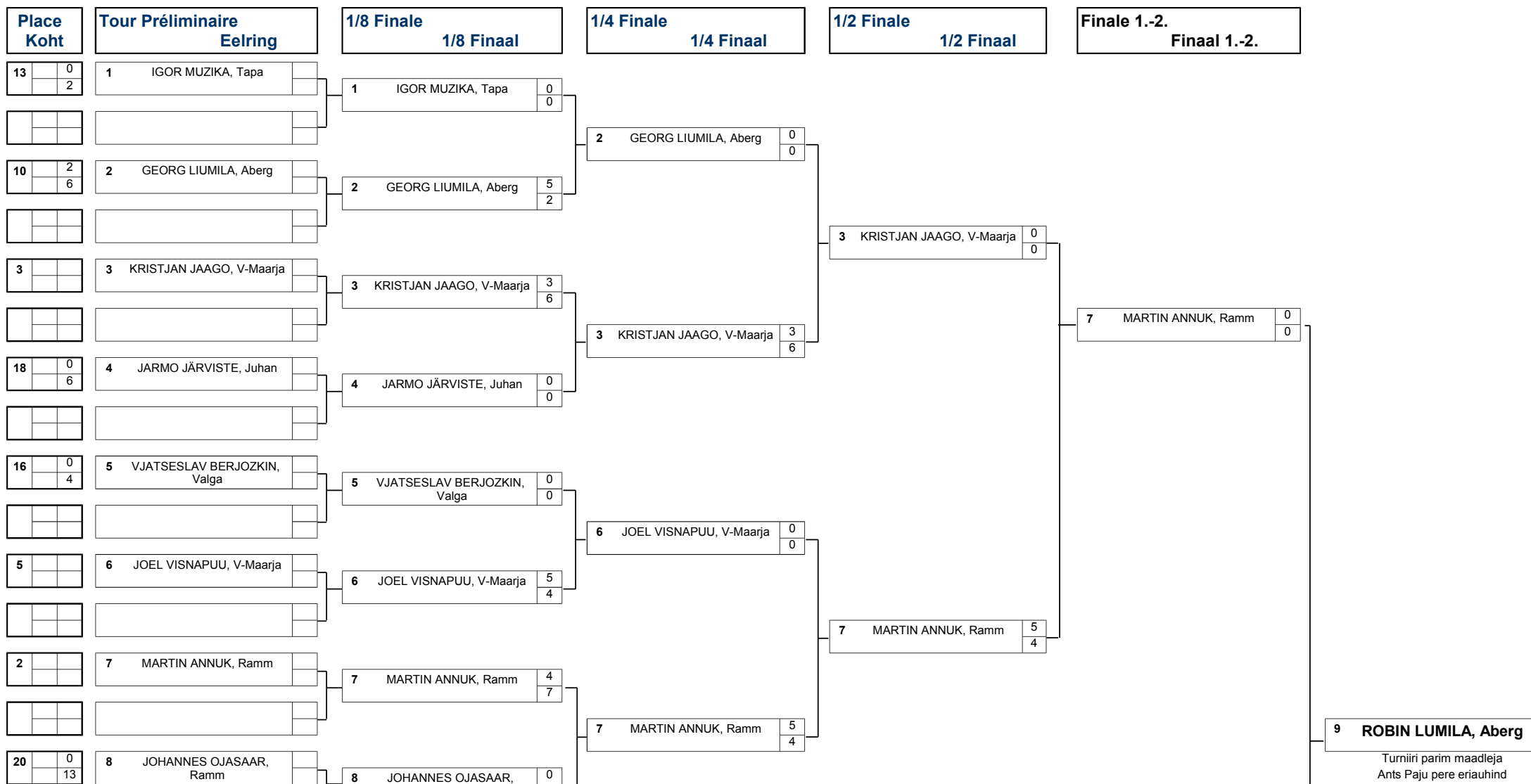

Turniiri parim maadleja
Ants Paju pere eriauhind

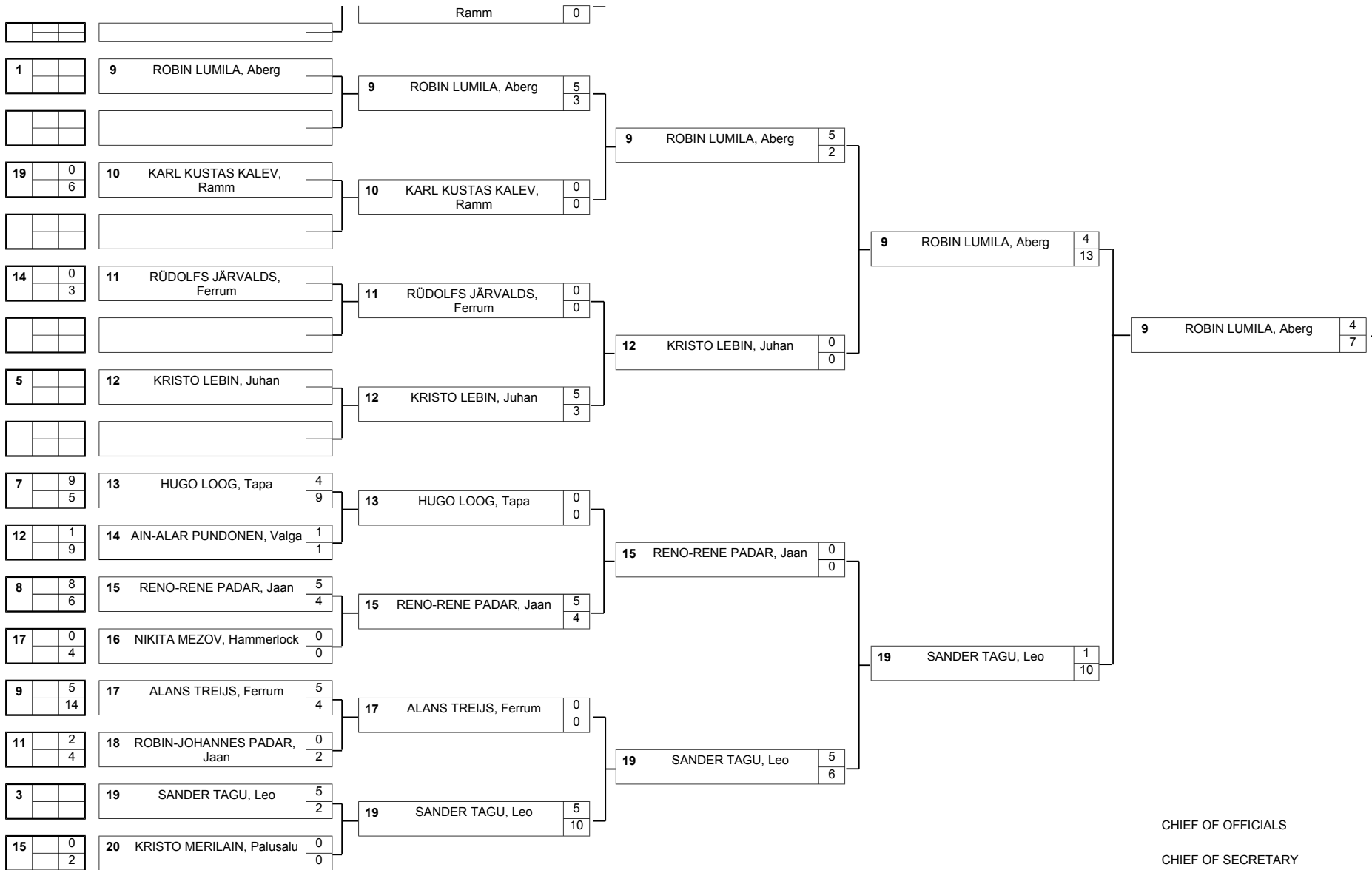

CHIEF OF OFFICIALS

Endel Treiman

CHIEF OF SECRETARY

Kättri-Avelin Säärits

REPECHAGE / LOHUTUSRINGID

Perdants contre le 1er Finaliste

Esimesele finalistile kaotajad

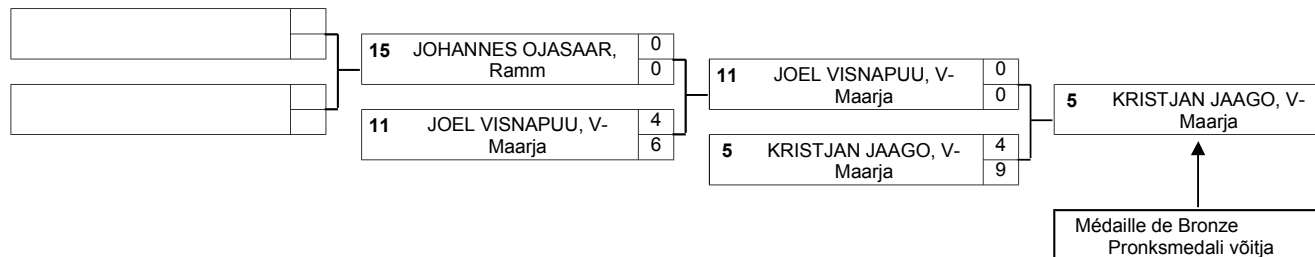

Perdants contre le 2 ème Finaliste

Teisele finalistile kaotajad

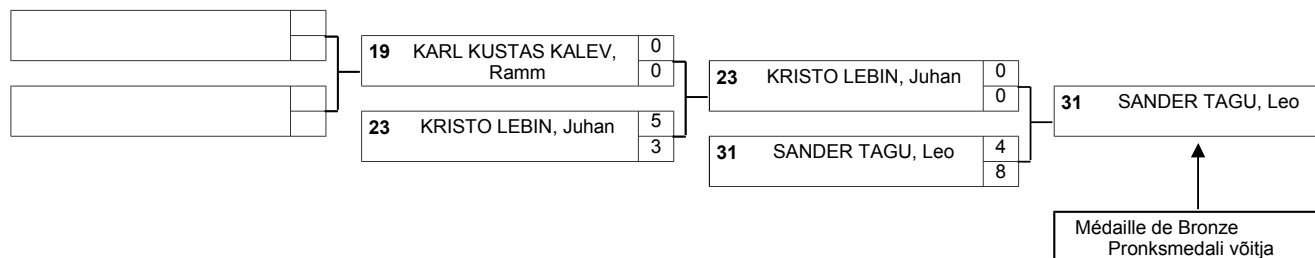

Vooremaa 34. meistrivõistlused kreeka-roma maadluses

Jõgeva
19.10.2013

35 KG

Place Koht	Tour Préliminaire Eelring	1/8 Finale 1/8 Finaal	1/4 Finale 1/4 Finaal	1/2 Finale 1/2 Finaal	Finale 1.-2. Finaal 1.-2.
1	1 KALLE LAISARV, Tapa	1 KALLE LAISARV, Tapa 5/4	1 KALLE LAISARV, Tapa 4/7	1 KALLE LAISARV, Tapa 5/4	1 KALLE LAISARV, Tapa 4/11
18	2 SILVER SUNNI, Hammerlock	2 SILVER SUNNI, Hammerlock 0/0			
3	3 ANDER JÄRV, Ramm	3 ANDER JÄRV, Ramm 5/4	3 ANDER JÄRV, Ramm 0/0		
14	4 HENDRIK RÄMMAN, Martna	4 HENDRIK RÄMMAN, Martna 0/0			
5	5 HANNO KÄÄRIK, Lapiti	5 HANNO KÄÄRIK, Lapiti 5/5	5 HANNO KÄÄRIK, Lapiti 5/3		
15	6 ANDREAS SOONSEIN, Ramm	6 ANDREAS SOONSEIN, Ramm 0/0		5 HANNO KÄÄRIK, Lapiti 0/0	
17	7 GIRTS JAKOVLEVS, Ferrum	7 GIRTS JAKOVLEVS, Ferrum 0/0			
9	8 DAN ŠEMELJOV, Valga	8 DAN ŠEMELJOV, Valga 4/4	8 DAN ŠEMELJOV, Valga 0/0		1 KALLE LAISARV, Tapa 1. KOHT

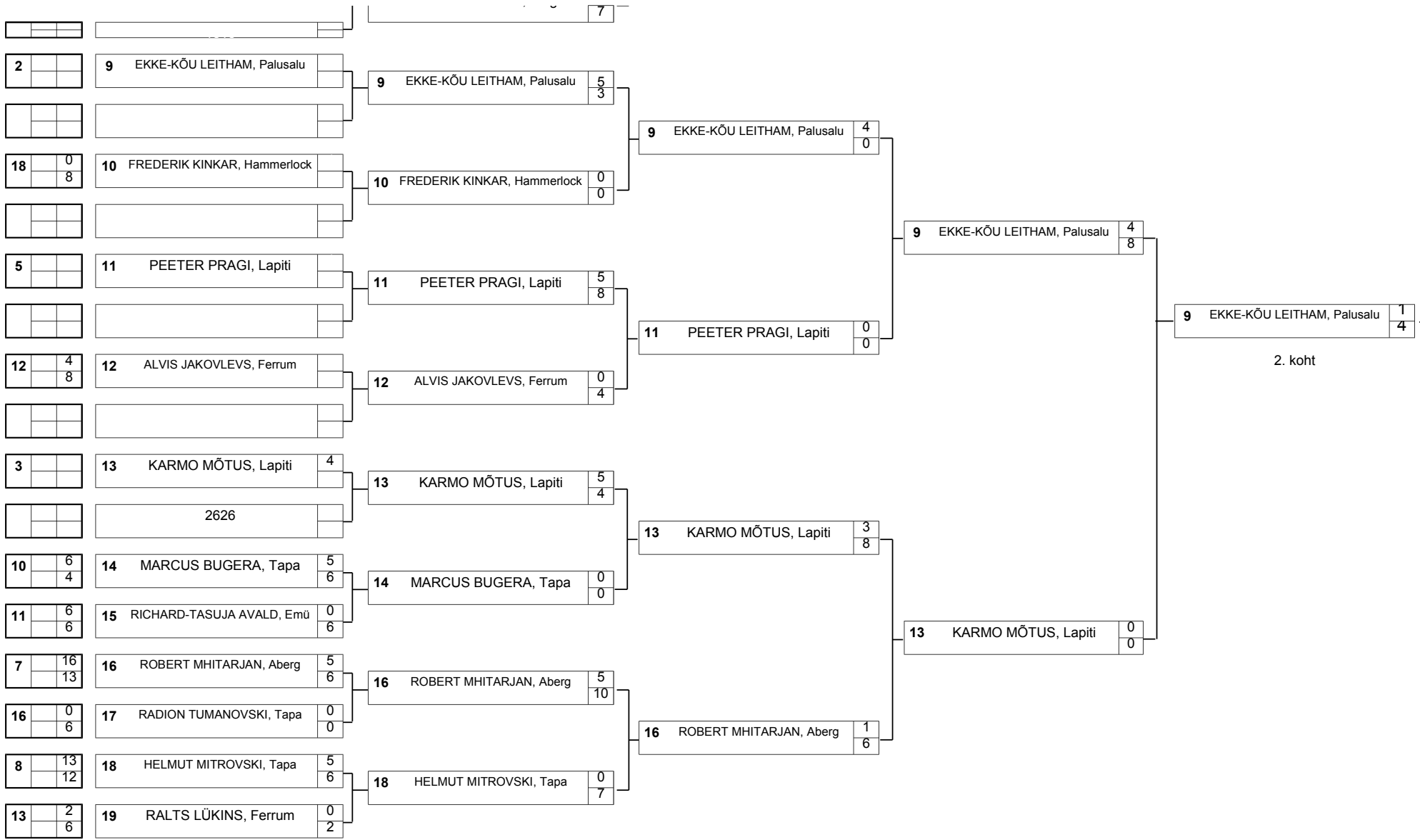

REPECHAGE / LOHUTUSRINGID

Perdants contre le 1er Finaliste

Esimesele finalistile kaotajad

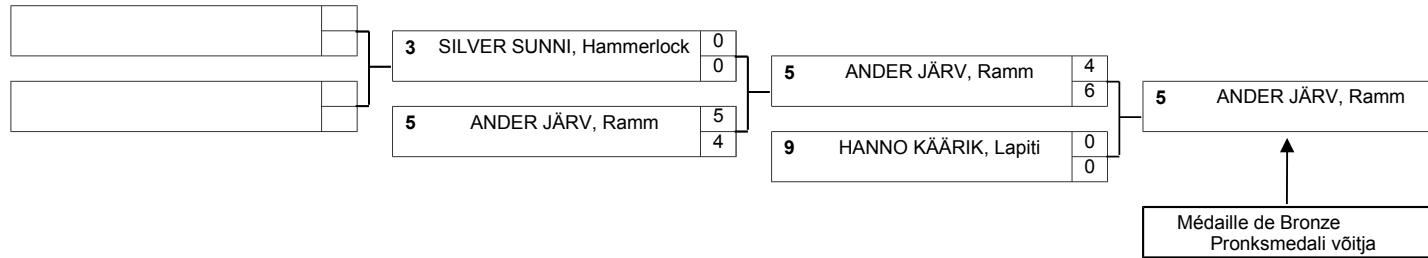

Perdants contre le 2ème Finaliste

Teisele finalistile kaotajad

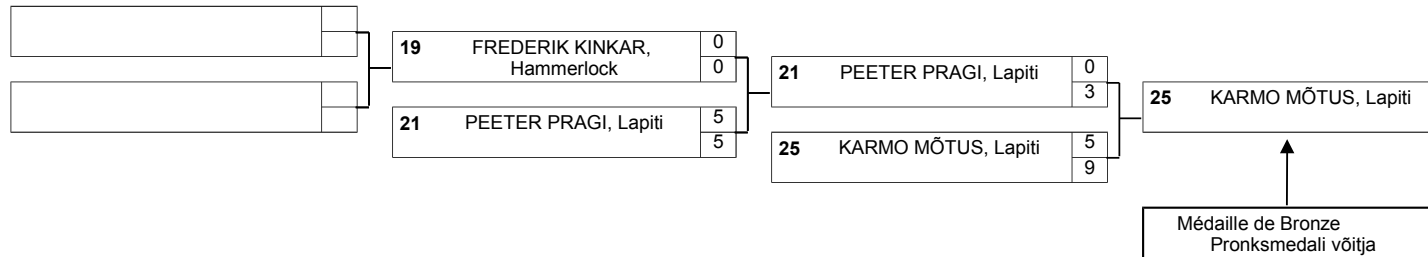

Vooremaa 34. meistrivõistlused kreeka-rooma maadluses

Jõgeva

19.10.2013

Weight category Kaal N 40 kg

Place Koht	Tour Préliminaire Eelring	1/2 Finale 1/2 Finaal	Finale 1.-2. Finaal 1.-2.
3	1 ARON AUN, Juhan 5/5	1 ARON AUN, Juhan 0/0	3 RAIMOND UIBO, Leo 3/5
7	2 MATVEI STARIKOV, Aberg 0/2		
1	3 RAIMOND UIBO, Leo 5/7	3 RAIMOND UIBO, Leo 5/8	3 RAIMOND UIBO, Leo
5	4 STEVEN VAIGU, Rakvere 0/0		
2	5 JEGOR SAHNO, Tapa 5/4	5 JEGOR SAHNO, Tapa 5/5	5 JEGOR SAHNO, Tapa 1/2
3	6 STEVEN TILGAR, Jaan 0/0		
8	7 DANIEL TŠIRONOV, Tapa 0/0	8 REENO-AKSEL AAVA, V-Maarja 0/0	
5	8 REENO-AKSEL AAVA, V-Maarja 5/3		

CHIEF OF OFFICIALS
CHIEF OF SECRETARY

Endel Treiman
Kätri-Avelin Säärts

REPECHAGE / LOHUTUSRINGID	
Perdants contre le 1er Finaliste Esimesele finalistile kaotajad	Perdants contre le 2ème Finaliste Teisele finalistile kaotajad
4 STEVEN VAIGU, Rakvere 0/3	6 STEVEN TILGAR, Jaan 3/6
1 ARON AUN, Juhan 5/11	8 REENO-AKSEL AAVA, V-Maarja 1/4
1 ARON AUN, Juhan Médaille de Bronze Pronksmedali võitja	6 STEVEN TILGAR, Jaan Médaille de Bronze Pronksmedali võitja

Vooremaa 34. meistrivõistlused kreeka-romaa maadluses

Jõgeva
19.10.2013

Weight category Kaal N 50 kg

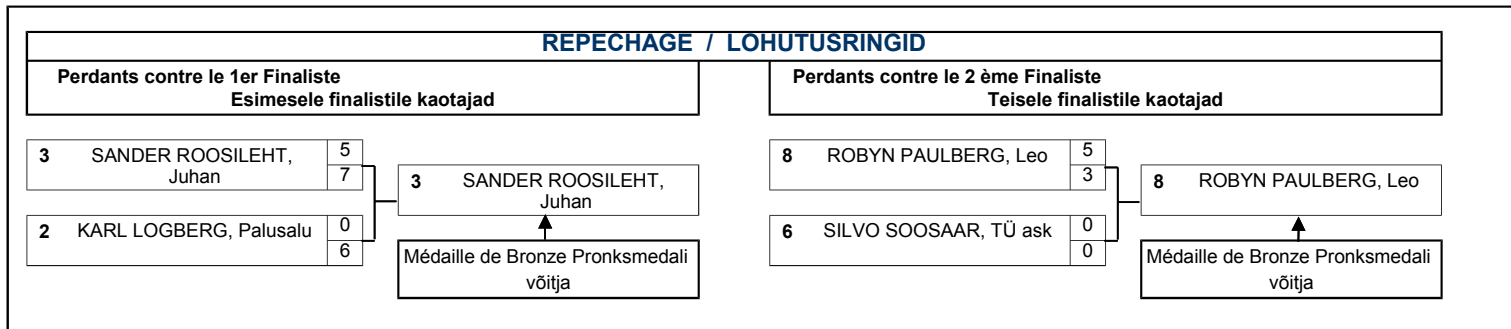
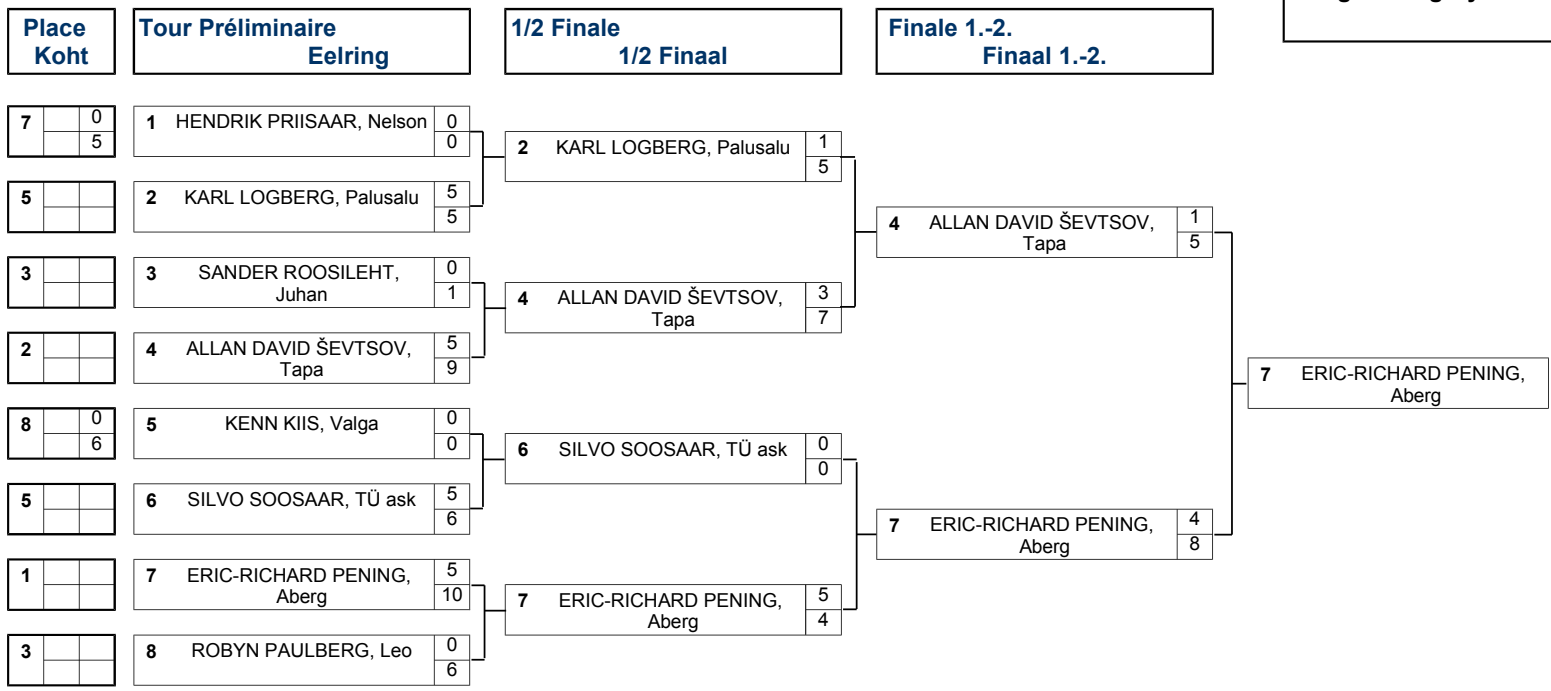

CHIEF OF OFFICIALS
CHIEF OF SECRETARY

Endel Treiman
Kätri-Avelin Säärts

Vooremaa 34. meistrivõistlused kreeka-rooma maadluses

Jõgeva
19.10.2013

Weight category
Kaal .+50 kg

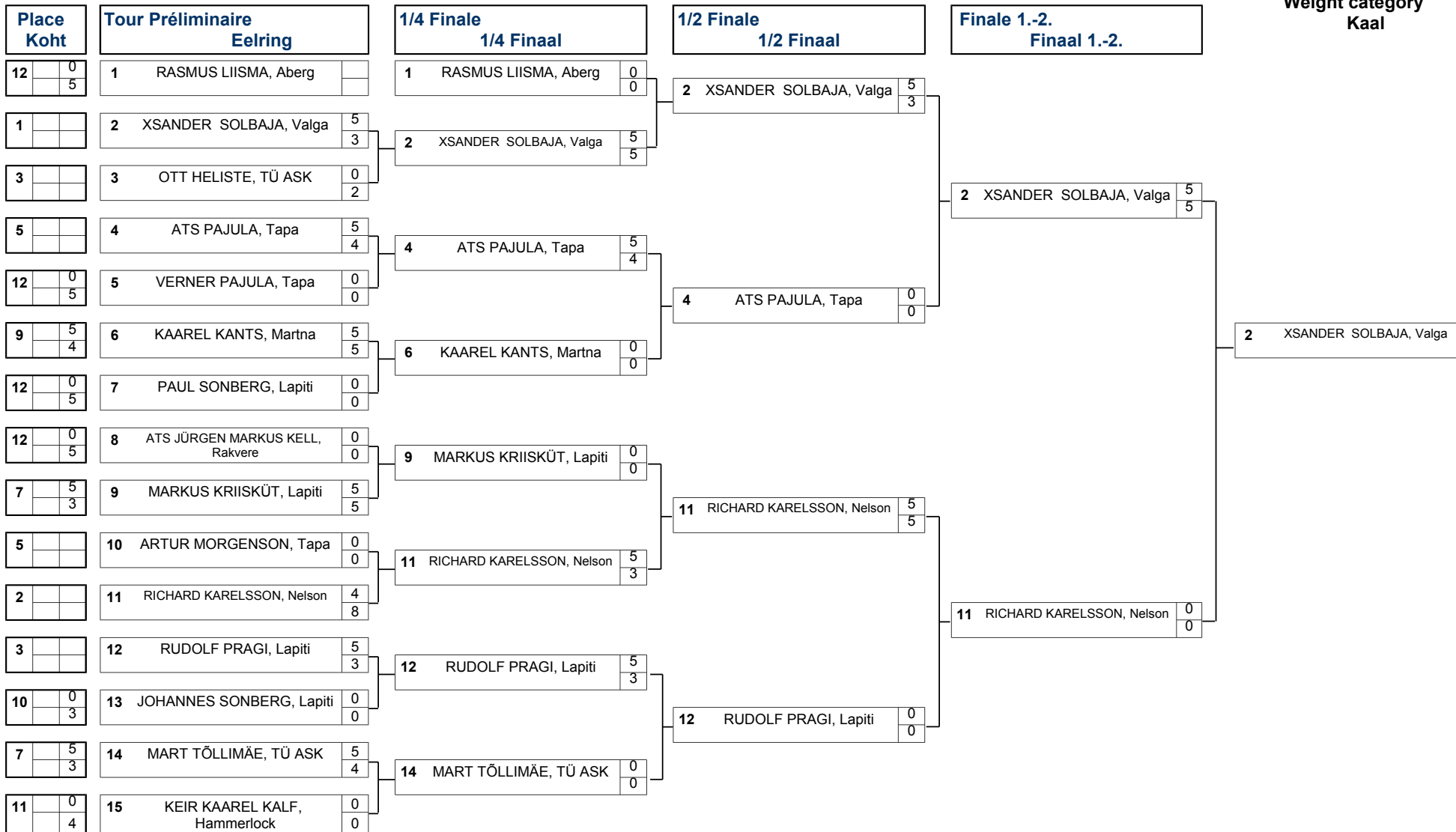

REPECHAGE / LOHUTUSRINGID

Perdants contre le 1er Finaliste Esimesele finalistile kaotajad

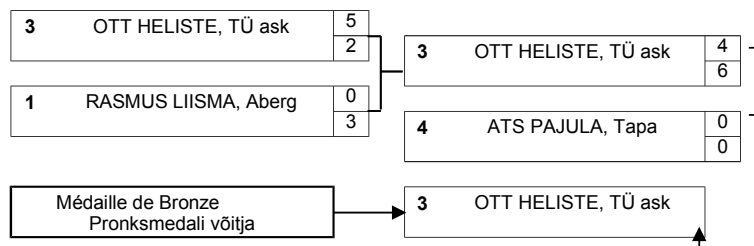

Perdants contre le 2 ème Finaliste Teisele finalistile kaotajad

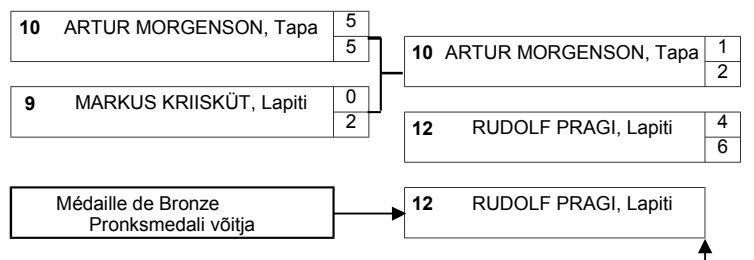

Vooremaa 34. meistrivõistlused kreeka-rooma maadluses

Jõgeva
19.10.2013

KLUBID		Õpilased 1998-2001										Noored 2002 ja nooremad							Kokku	
		32	35	38	42	47	53	59	66	73	85	20	25	30	35	40	50	.+50	PUNKTID	KOHT
1	RJK Ramm			5			5							5	4			19	9	
2	SK Tapa						7 4 2				7		2		7	5	5	2	41	2
3	SK Kadrina	7		7 4	4	2	2						5 2					33	3	
4	SK Rakvere										5				2			7	16	
5	Väike-Maarja Valla RSK													4 2		2		8	15	
6	SK Martna	5																5	17	
7	MK Lapiti														2 4 2		4	12	12	
8	SK Leo							7				4	4		7	4		26	5	
9	MK Juhan					4		7 4	5 4	7 5	3			2		4	4	49	1	
10	MK Hammerlock									3								3	18	
11	K. Palusalu SK					5		5				7	7		5		2	31	4	
12	MK Nelson				7	7											5	19	8	
13	MK Aberg		7							4				7			7	25	6	
14	EMÜ SK							3										3	18	
15	TÜ ASK					4 2										2	4	12	12	
16	MK Jaan				5					4		3			4			16	10	
17	Tartumaa ML				3		4		4 2									13	11	
18	Valga SK		5	3							2		4				7	21	7	
19	Ferrum Lat											5 4						9	14	